

North

Design by Arik Levy.

North pendants provide elegant and adjustable solutions to bring light where's its needed. Poised to light surfaces of any size or height, this collection can be personalized with the typology, shade and finish to fit your project and style.

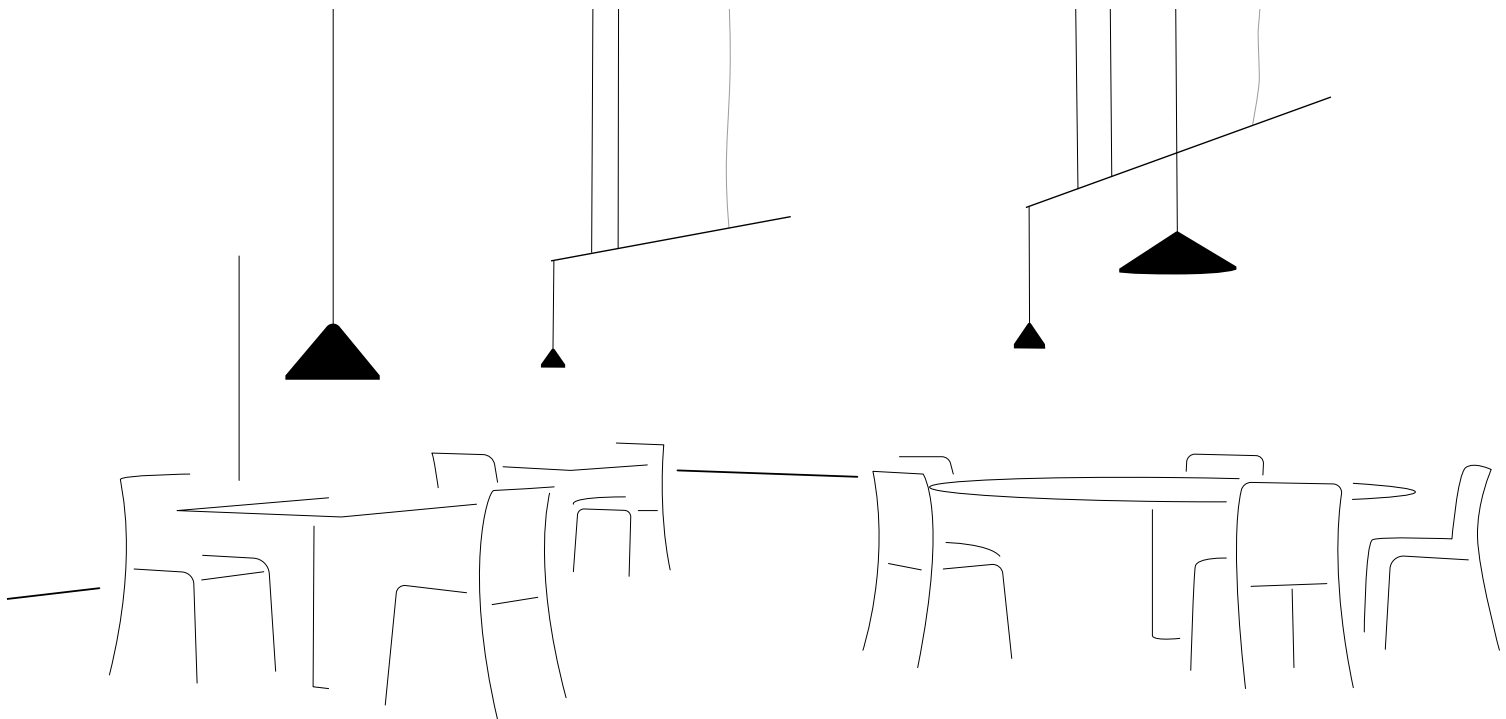



Triangular aluminum shades hang from adjustable carbon fibre rods in North pendant. The rod and shade are disconnected from one another via nearly invisible cables in a dynamic system of adjustable parts, directing the LED-powered light where needed. Creating a tighter angle with the shade casts a focused pool of downward light, while a wider slant traces an elegant, more open line that's subtle yet striking.

- 10 White (NCS S 0300-N)
- 11 Black (NCS S 8500-N)
- 24 Beige M1 (NCS S 2005-Y50R)
- 42 Blue M1 (NCS S 5010-B10G)

Diffuser: Methacrylate.
 Shade: Aluminum.
 Rods: Carbon Fiber.
 Canopy: Steel.

LED 2700 K. CRI>80. 116 lm/W.
 Dimming: 1-10V, Push.

Personalization options available

- LED 3000 K / 4000 K
 - Dimming: DALI, Casambi
 - Extra cable length
- Request more information.



5660

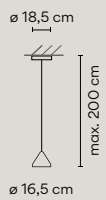

5662

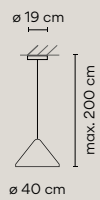

5664

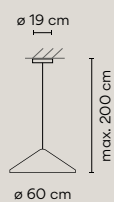

5670

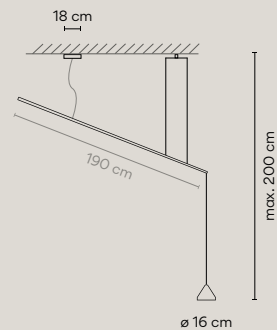

5672

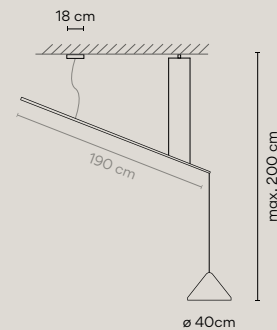

5674

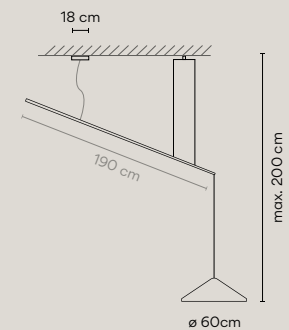

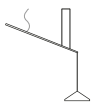

Pg 150

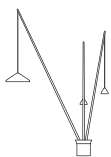

Pg 156



Pg 398

North



Design by Arik Levy.

North features a base, stem, and shade that are disconnected from one another in a dynamic system of adjustable parts. Protruding arms hold triangular shades that direct the light where needed.



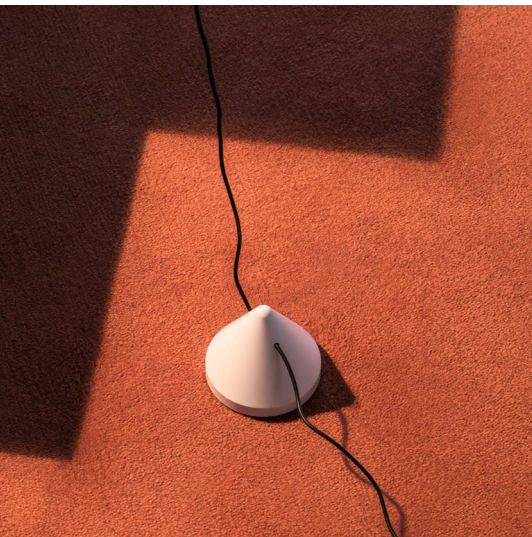

The counterweight placed on the ground guides the electrical cable and allows the stem and shade to be placed wherever required.

Push-button dimmer on the cable.
Electric cable with plug.

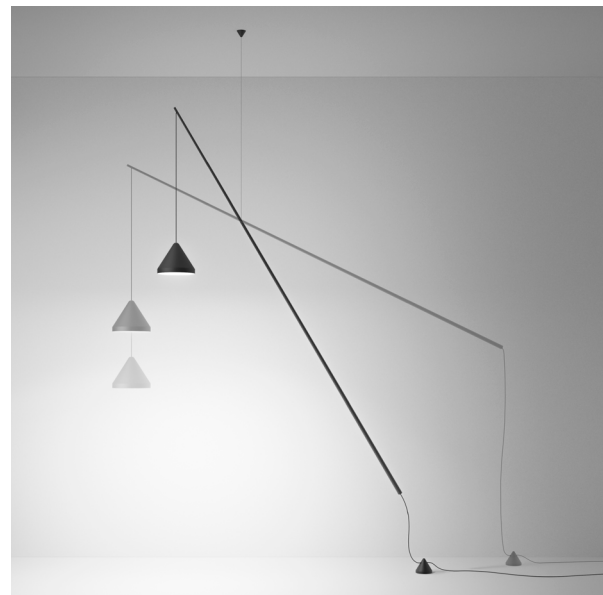







The North Floor Lamp is anchored to the floor by a base weighted with black stones. Protruding carbon fiber arms bear the triangular aluminum shades to direct the LED-powered light where needed. The base, stem, and shade are disconnected from one another in a dynamic system of adjustable parts. The tighter angle of the shade creates a focused pool of downward light in a desired area, while the softer slant of the carbon rod traces an elegant, more open line that's subtle yet striking.

- 10 White (NCS S 0300-N)
- 11 Black (NCS S 8500-N)
- 24 Beige M1 (NCS S 2005-Y50R)
- 42 Blue M1 (NCS S 5010-B10G)

Diffuser: Methacrylate.
 Shade: Aluminum.
 Rods: Carbon Fiber.
 Base: Steel.

LED 2700 K. CRI>80. 116 lm/W.
 Dimming: Push.

Personalization options available
 - LED 3000 K / 4000 K
 - Extra cable length (only ref. 5666)
 Request more information.

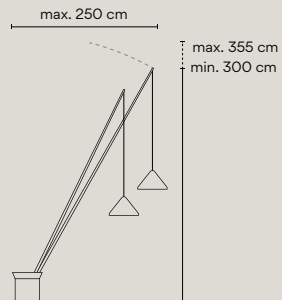

5600

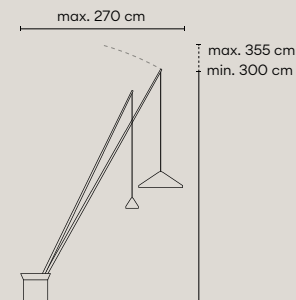

5605

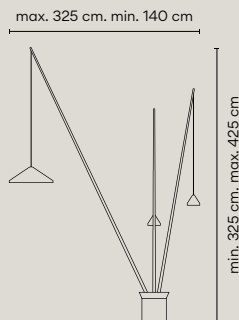

5620

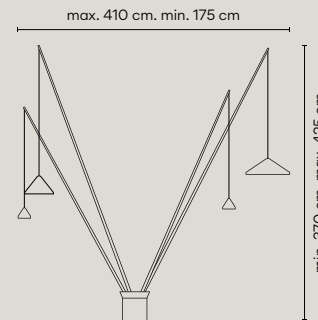

5625

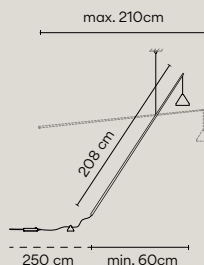

5666

Push-button dimmer on the base. Can be connected with or without plug.

Electric cable with plug.

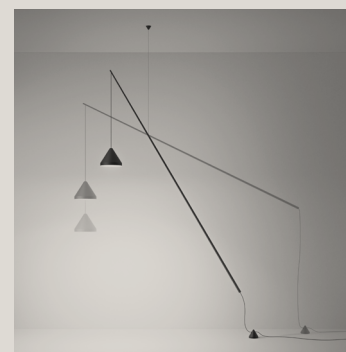

Pg 150

Pg 156

Pg 398



North



Design by Arik Levy.

The North wall lamp is an innovative synthesis of a suspension and wall fixture. The cable, stem, and shade are disconnected from one another in a dynamic system of adjustable parts that directs the LED-powered light where needed.



5630

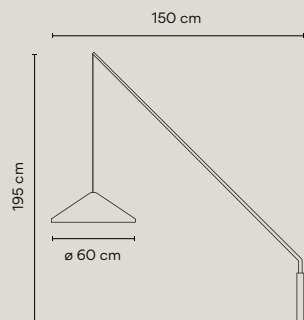

5635

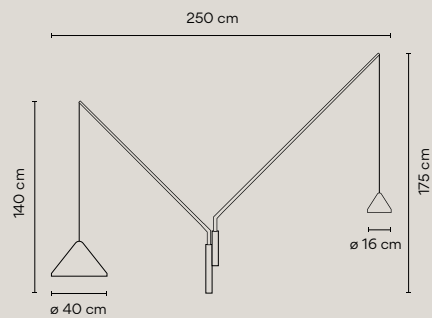

5640

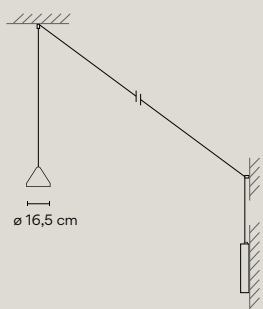

5642

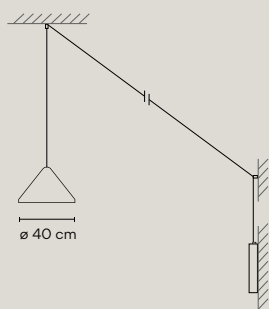

5644

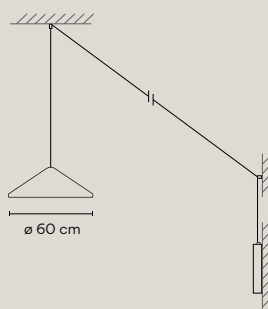

The North wall lamp is an innovative synthesis of a suspension and wall fixture. A triangular aluminum shade hangs from a nearly invisible cable that's attached to a slender carbon fibre stem secured to the wall. The cable, stem, and shade are disconnected from one another in a dynamic system of adjustable parts. Powered by an LED, the tighter angle of the shade creates a focused pool of downward light in a desired area, while the softer slant of the carbon rod traces an elegant, more open line that's subtle yet striking.

- 10 White (NCS S 0300-N)
- 11 Black (NCS S 8500-N)
- 24 Beige M1 (NCS S 2005-Y50R)
- 42 Blue M1 (NCS S 5010-B10G)

Diffuser: Methacrylate.

Shade: Aluminum.

Rods: Carbon Fiber.

Wall plate: Steel.

LED 2700 K. CRI>80. 116 lm/W.

Dimming: Push.

Push-button on the wall plate.
Can be connected with or without plug.

Ref. 5640, 5642, 5644.
Length of light electric cable 10m.

Personalization options available

- LED 3000 K / 4000 K
Request more information.

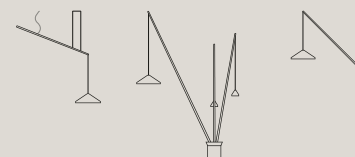

Pg 150

Pg 156

Pg 398

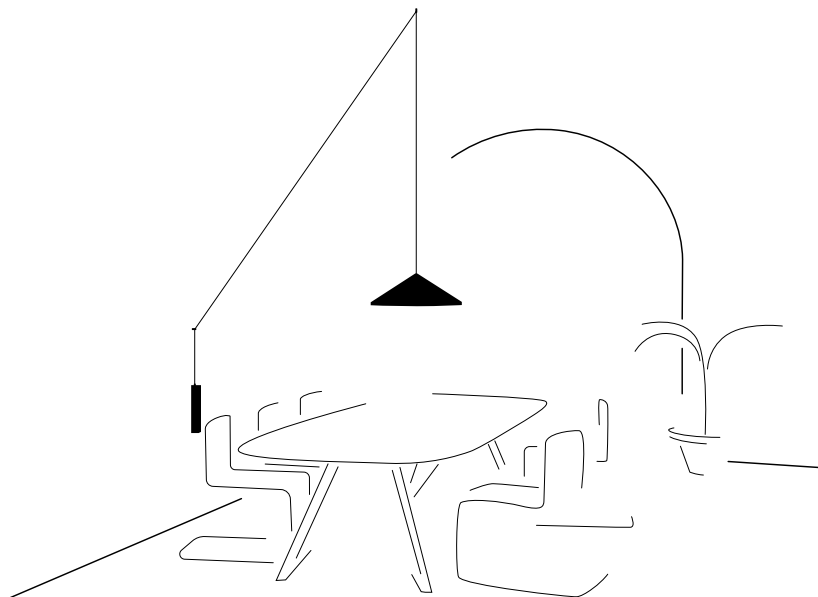
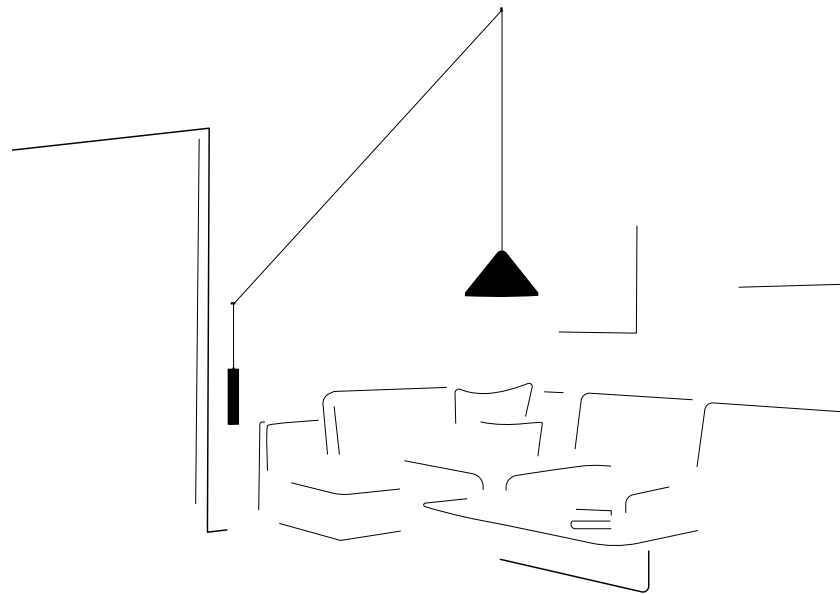
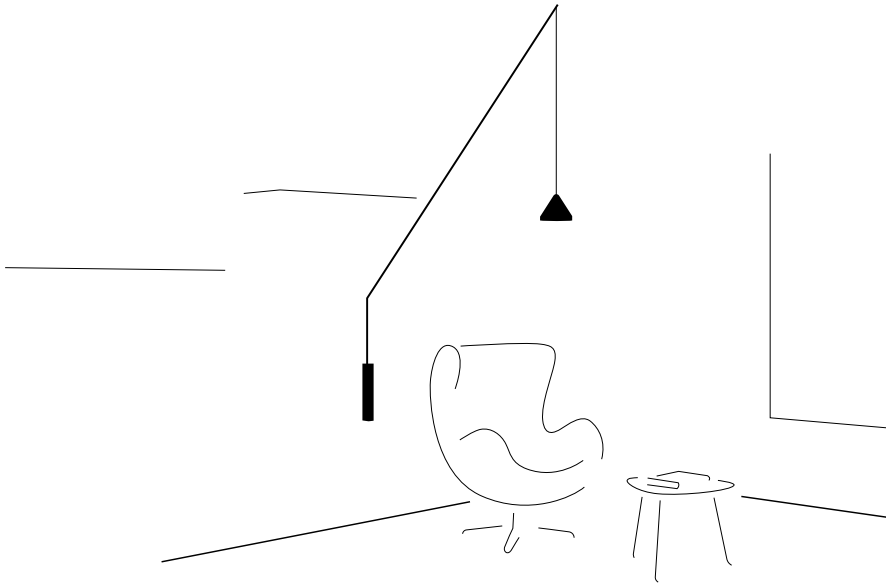

North combines pendant and wall application to provide elegant and adjustable solutions. Choose from different shade sizes to provide an either more focus or diffused beam of light. This collection can be personalized with the typology, shade and finish to fit your project and style.